

ISO 9001:2015

LEADS DIGITAL

— ONE STEP AHEAD OF SUCCESS —

— SECURE SOLUTIONS. SMARTER FUTURE. —



NETWORKING
Secure Connections



CYBER SECURITY
Protect What Matters



SURVEILLANCE
Smart Monitoring



**SOFTWARE
DEVELOPMENT**
Custom Solutions



**MOBILE APP
DEVELOPMENT**
Smart. Seamless. Scalable.



ADDRESS:

Regd. Off: Sailen Moulick Sarani,
Hridaypur, Barasat, Kolkata,
W.B., India 700127



PHONE:

+91 8240245144 / 8296343757



WEBSITE:

www.theleadsdigital.com |
www.leadstocompany.com



EMAIL:

support@leadstocompany.com
contact@theleadsdigital.com



SCAN TO CONNECT





YOUR
STRATEGIC
TECHNOLOGY
PARTNER

COMPANY OVERVIEW

WHO WE ARE

Leads Digital is a delivery-focused software and hardware solutions company with deep expertise across Healthcare, Finance, EdTech, Logistics, and Enterprise Systems. As an **ISO 9001:2015 certified company**, we are committed to delivering high-quality, reliable, and future-ready solutions tailored to modern business needs.



- INDUSTRY INSIGHT**
Deep real-world domain expertise across sectors
- ENTERPRISE ENGINEERING**
Robust, scalable ISO-aligned system design
- OPERATIONAL PRAGMATISM**
Practical, delivery-focused runbook and ops

WE SPECIALIZE IN BUILDING ROBUST, SCALABLE, AND SECURE TECHNOLOGY ECOSYSTEMS.

Our solutions streamline operations, reduce manual workload, and enable organizations to achieve measurable growth across multiple industries worldwide.



CERTIFIED EXCELLENCE

ISO 9001:2015 certification reflects our unwavering commitment to quality, reliability, and consistent service delivery across all engagements



RESULT-DRIVEN SOLUTIONS

We combine real-world industry understanding with enterprise-grade engineering to deliver not just services—but complete, result-driven technology ecosystems



**Electronics and Computer Software
Export Promotion Council**

Proud to be a member of Electronics and Computer Software Export Promotion Council of India, under **Ministry of Commerce & Industry**.



We are registered and accredited with **Udyam** since from 2024. We are focused to serve medium & micro industries tirelessly. Big corporates are also targeted to cover up.

OUR VISION & MISSION

To become a trusted global technology partner enabling organizations—especially in healthcare—to operate efficiently, securely, and digitally. Every solution we build is guided by four core mission pillars.



RELIABLE & SCALABLE SOLUTIONS

Deliver networking and software solutions that grow alongside your organization, ensuring performance and stability at every stage of your digital journey.



OPERATIONAL EFFICIENCY

Enhance workflows through intelligent automation, reducing manual workload and enabling teams to focus on high-value activities that drive measurable business outcomes.



SECURITY & LONG-TERM PARTNERSHIP

Ensure data security and system stability in critical environments while building lasting partnerships grounded in quality, transparency, and mutual trust.



TEAM EXPERTISE & CERTIFICATIONS

Our strength lies in our skilled and certified professionals across multiple technical domains. We are equipped to handle both infrastructure-level deployments and enterprise software systems efficiently.



NETWORK & SECURITY ENGINEERS

CISCO certified network engineers and network security specialists, including Certified Ethical Hackers (CEH) with hands-on deployment experience.



SOFTWARE DEVELOPERS

Experienced frontend and backend developers (B.Tech/BCA) capable of building scalable enterprise applications, custom business systems, and mobile platforms.



CLOUD & DEVOPS ENGINEERS

AWS and Azure certified cloud engineers and system administrators managing hybrid infrastructure, cloud servers, and remote monitoring environments.



NETWORKING & NETWORK SECURITY SOLUTIONS

We provide end-to-end networking solutions designed for environments where uptime, security, and reliability are critical—such as hospitals. Our goal is a stable, secure, and future-ready network environment for uninterrupted operations.

★ NETWORK INFRASTRUCTURE & HOSPITAL DESIGN

Complete LAN/WAN design, structured cabling, department-wise connectivity (OPD, IPD, Labs, Admin), segmented networks, and high-availability architecture

📈 SECURITY & VAPT

Firewall setup, intrusion detection/prevention, secure VPN, vulnerability assessment, penetration testing, compliance hardening, and security risk analysis

📄 SERVER, CLOUD & DATA PROTECTION

On-premise and cloud server setup, automated backup systems, disaster recovery planning, data encryption, and hybrid remote infrastructure management

📄 PRIMARY FOCUS: HEALTHCARE NETWORKS

Our hospital network design ensures secure, segmented, and high-availability connectivity for critical departments—enabling uninterrupted clinical and administrative operations.

KEY SOLUTION AREAS

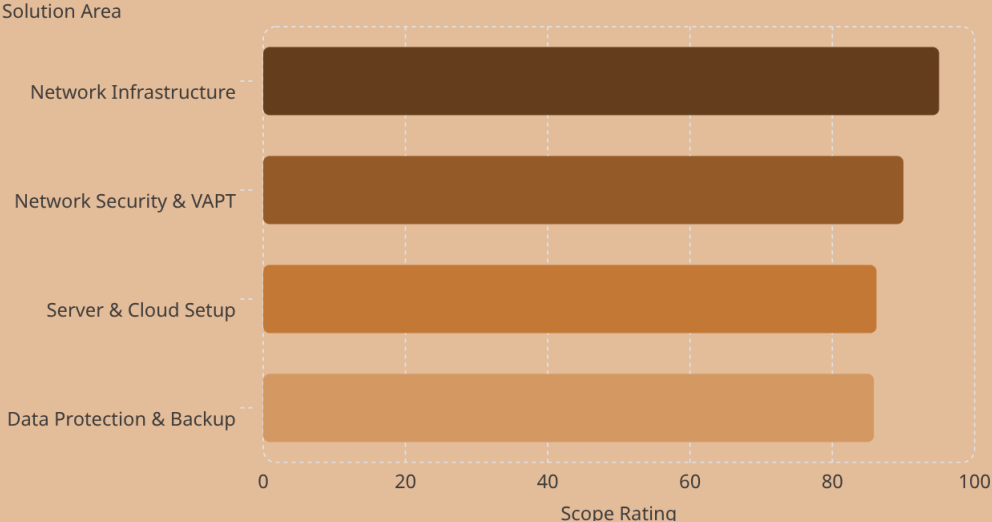

ADD-ON & SOFTWARE DEVELOPMENT SERVICES

To provide a complete infrastructure solution, we offer integrated physical security and safety systems alongside enterprise-grade software capabilities for the next phase of digital transformation.

SURVEILLANCE, FIRE & ACCESS CONTROL

HD CCTV installation, central monitoring, fire and smoke detection sensors, alarm systems, biometric/RFID access control, and restricted area management for complete physical security.

HOSPITAL INFORMATION SYSTEM (HIS)

Patient registration, OPD/IPD management, billing, pharmacy and inventory, diagnostics, reports, and Electronic Medical Records (EMR) for end-to-end hospital digitization. You can customize your options through our portal.

HOSPITAL COMMUNICATION SYSTEM

We design internal communication system e.g., Nurses calling system, IPBAX/EPABX, Internal Announcing system to make the hospital operations smooth and faster. All these architecture and integrations are done by our experts.

ENTERPRISE SOFTWARE SOLUTIONS

ERP, CRM, custom business applications, and mobile platforms (Android & iOS) enabling seamless integration between network infrastructure and software systems. You can make your own mobile app for your customers to maintain a seamless communication.

INTERNATIONAL DIVERSIFIED PROJECT PORTFOLIO

- 1 GERMANY – GOOGLE REVIEW ANALYTICS PLATFORM**
Automated sentiment scoring and reporting dashboard for international client engagement and business intelligence.
- 2 CANADA – INTERNATIONAL BANK VAPT**
Full security hardening and vulnerability assessment and penetration testing implementation for a leading international financial institution.
- 3 CANADA – FOOD DELIVERY PLATFORM**
Real-time tracking and multi-role mobile application for a high-traffic food delivery service with complex logistics requirements.
- 4 JAPAN – DEDICATED PYTHON PROJECT**
Our expert team is deployed to the Japanese software giant as in turnkey project basis. 160 hours is given by the developers to the organization since from last one year.

INDIA

ERP & CRM systems for manufacturing and service industries with full workflow automation

MALAYSIA

Enterprise ERP with inventory, HR, finance, and role-based access controls for large-scale operations

FRANCE

Microfinance loan management system with complete lifecycle tracking and reporting dashboards

ZIMBABOWE – Learning Management System deployed for government schools with large-scale, multi-institution rollout.

INDUSTRY EXPERTISE & GLOBAL PRESENCE

We proudly serve clients across India, the Middle East, Africa, and Europe. Our international exposure ensures we follow global standards in technology, security, and scalability across a diverse range of industries.



HEALTHCARE & FINANCE

Deep domain expertise in hospital systems, banking security, insurance platforms, and wellness technology—sectors where reliability and compliance are non-negotiable.



EDTECH, LOGISTICS & ENTERPRISE

Proven delivery across education, logistics, manufacturing, retail, real estate, and public sector—from LMS platforms to ERP systems and supply chain solutions.



EMERGING & NICHE MARKETS

Experience serving Agriculture, Media & Entertainment, Legal & Compliance, Automotive, NGOs, and IT & SaaS companies with purpose-built technology solutions.

Retail & E-Commerce · Finance & Banking · Healthcare & Wellness · Education & EdTech · Logistics & Transportation · Manufacturing · Real Estate · Hospitality · Legal & Compliance · IT & SaaS · Agriculture · Media & Entertainment · Insurance · Automotive · Public Sector · NGOs

DIFFERENT NETWORK TOPOLOGIES (WORLD CLASS)

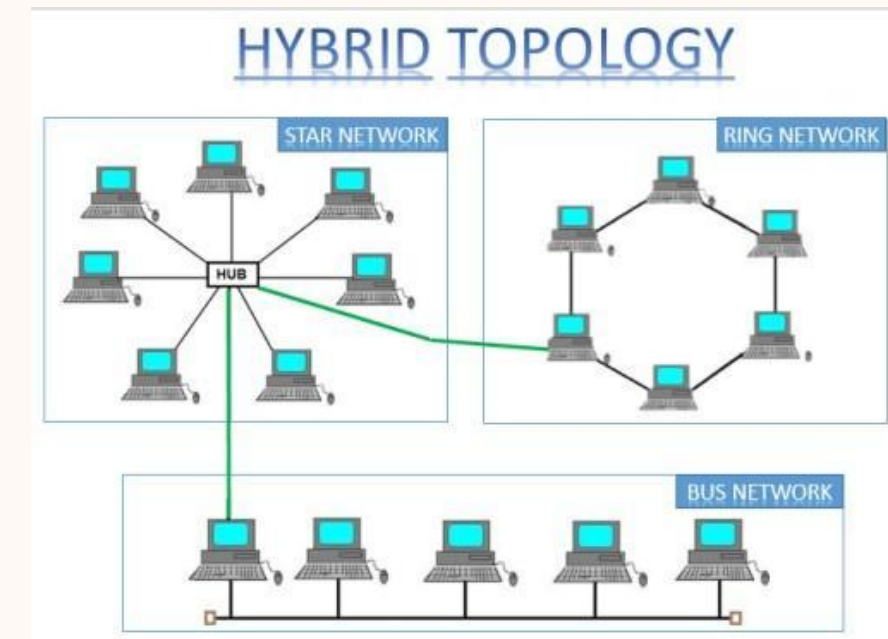
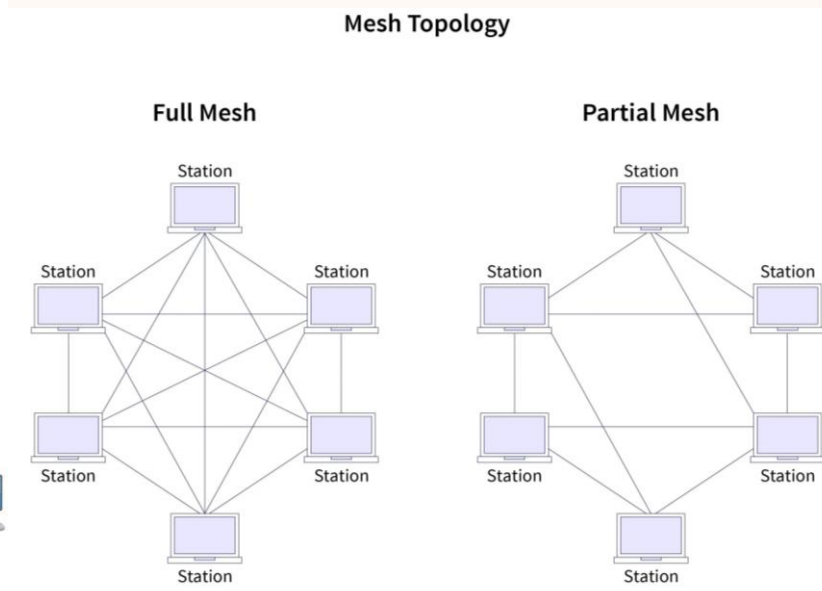
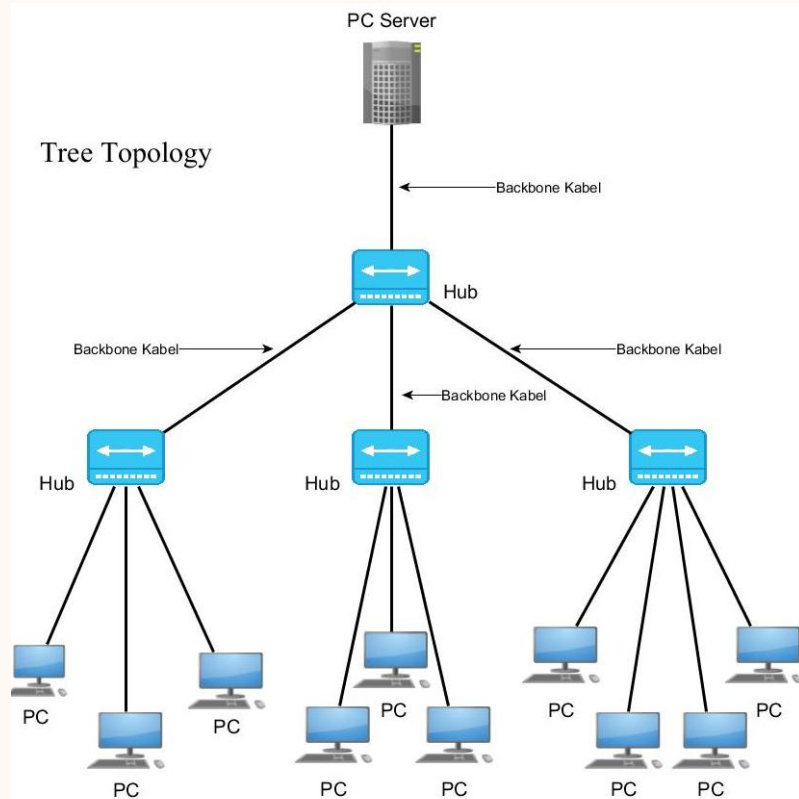
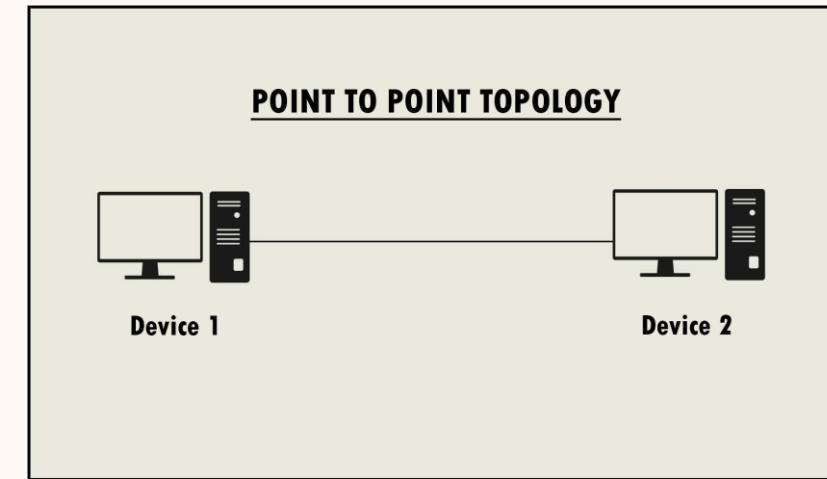
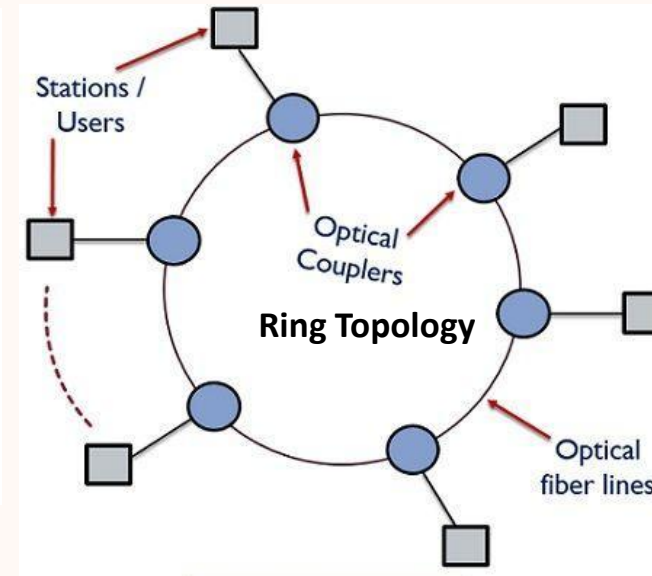
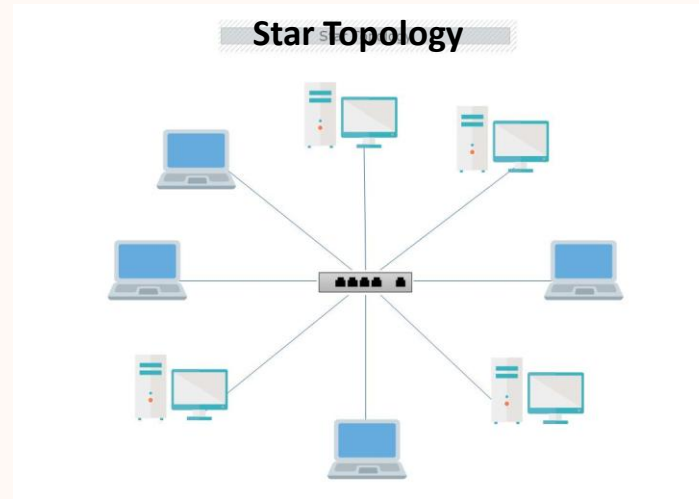
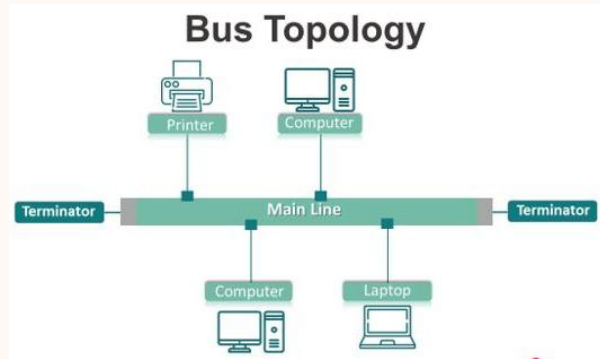

OUR STRUCTURAL NETWORK DESIGN SAMPLES

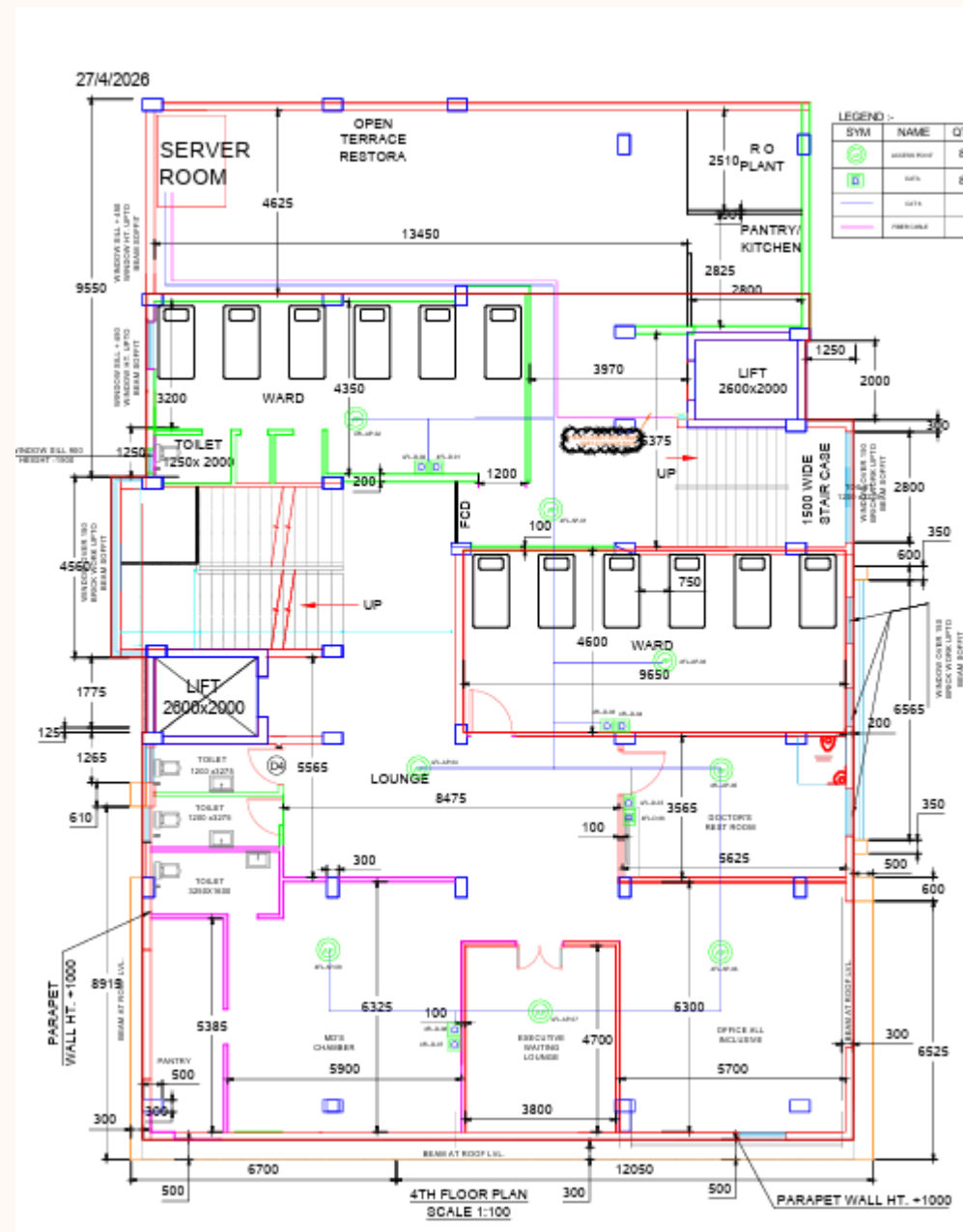
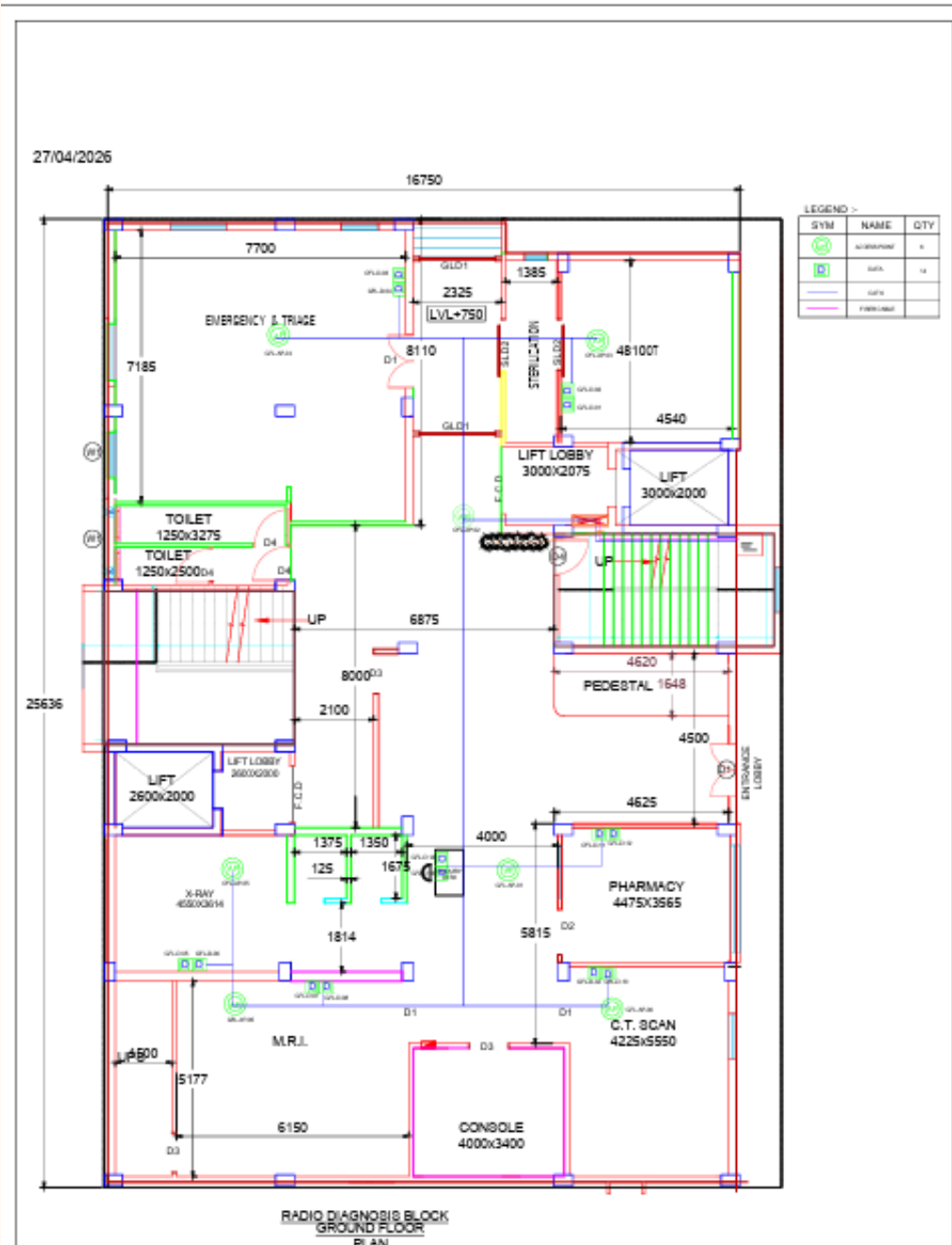

▶ OUR COMMITMENT

WHY PARTNER WITH LEADS DIGITAL

Leads Digital aims to be more than just a service provider—we strive to be a **long-term technology partner**. Our approach begins with a strong, secure networking foundation, enabling future expansion into advanced software systems and creating a complete digital ecosystem.

RELIABILITY

Stable, always-on infrastructure and software systems engineered for critical and high-availability environments

SECURITY

End-to-end data protection, VAPT, firewall hardening, and compliance built into every solution we deliver

SCALABILITY

Architecture designed to grow with your organization—from single-site deployments to multi-region enterprise systems

LONG-TERM VALUE

We invest in your success beyond project delivery, building partnerships grounded in quality, trust, and continuous improvement

Let's build a secure and future-ready infrastructure together. Leads Digital — *Your Trusted Technology Partner*

Regd. Off: Sailen Moulick Sarani, Hridaypur, Barasat, Kolkata, W.B., India 700127 | Website: www.theleadsdigital.com www.leadstocompany.com
| Phone: +91 8240245144/8296343757 | Email: contact@theleadsdigital.com networkadmin@theleadsdigital.com

LEADS DIGITAL